

Kellerplan vorbehaltlich technischer Änderungen!!!

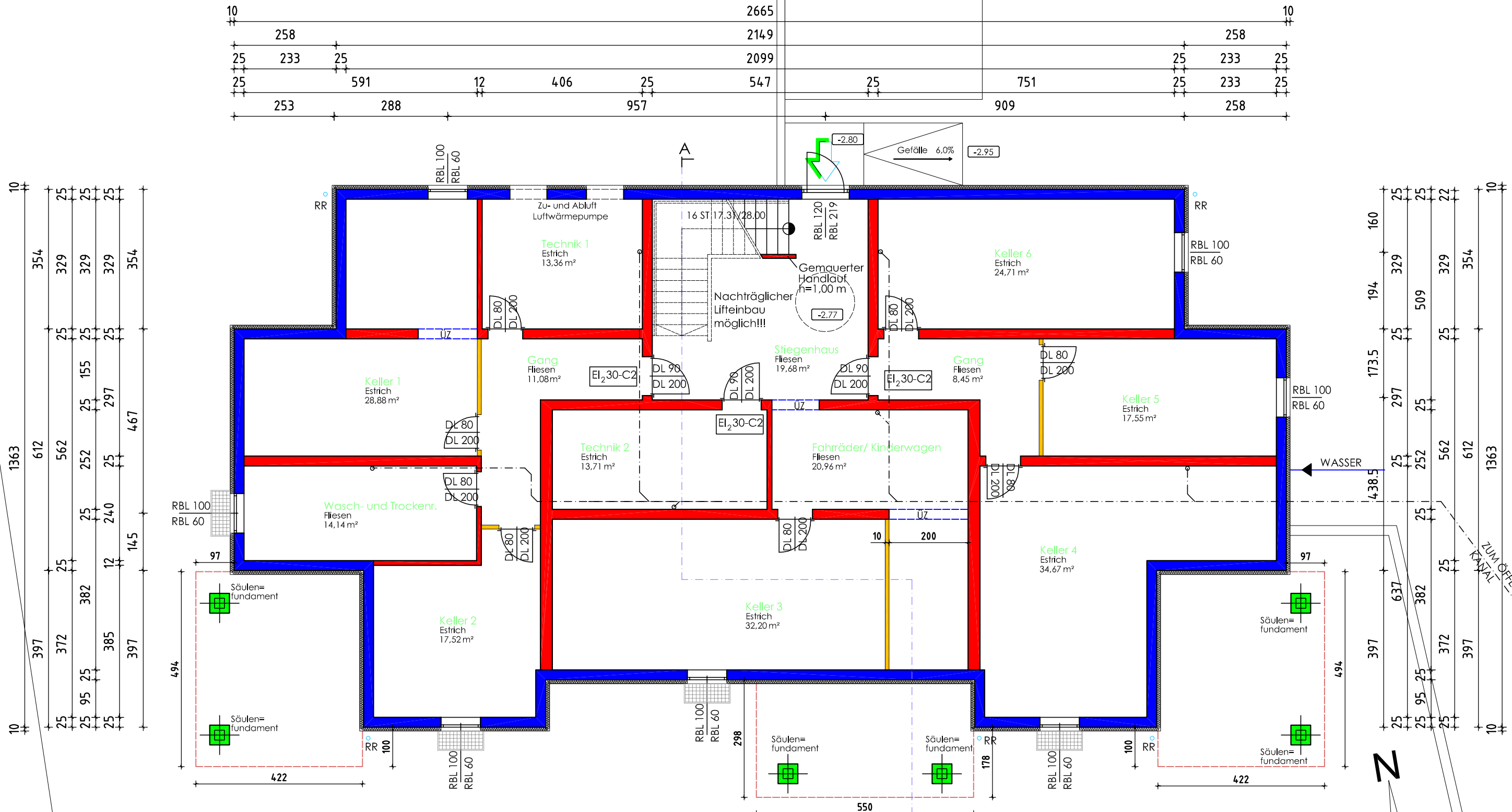

RBL=Rohbaulichte  
DL = Durchgangslichte

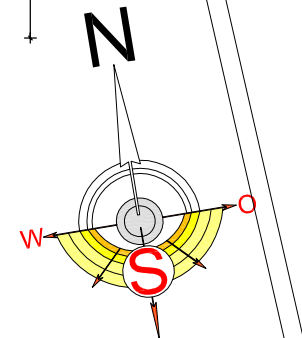
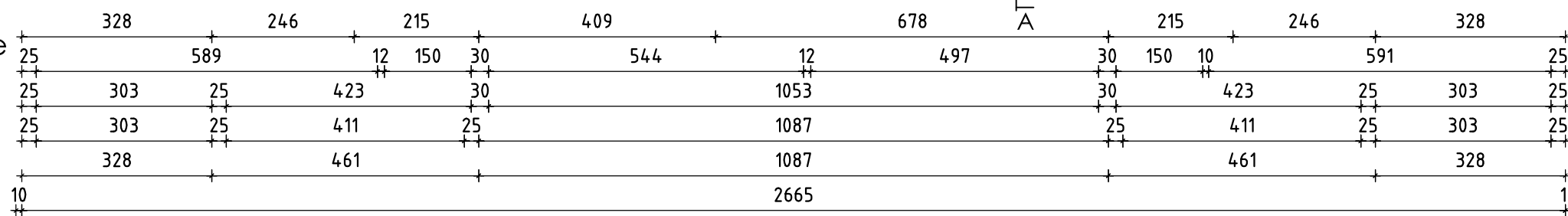

KELLER

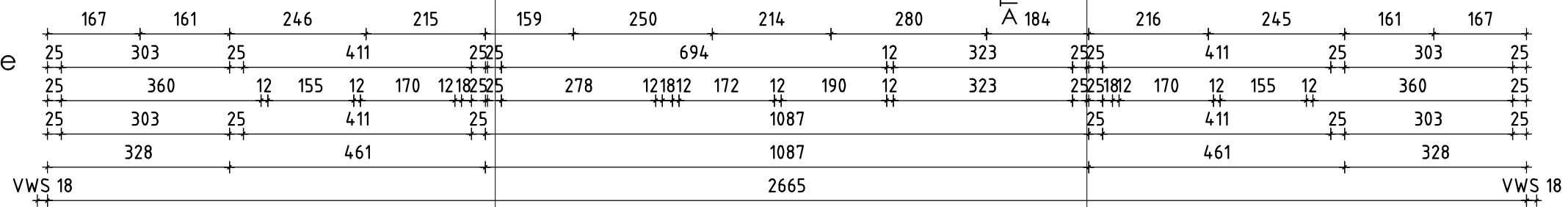
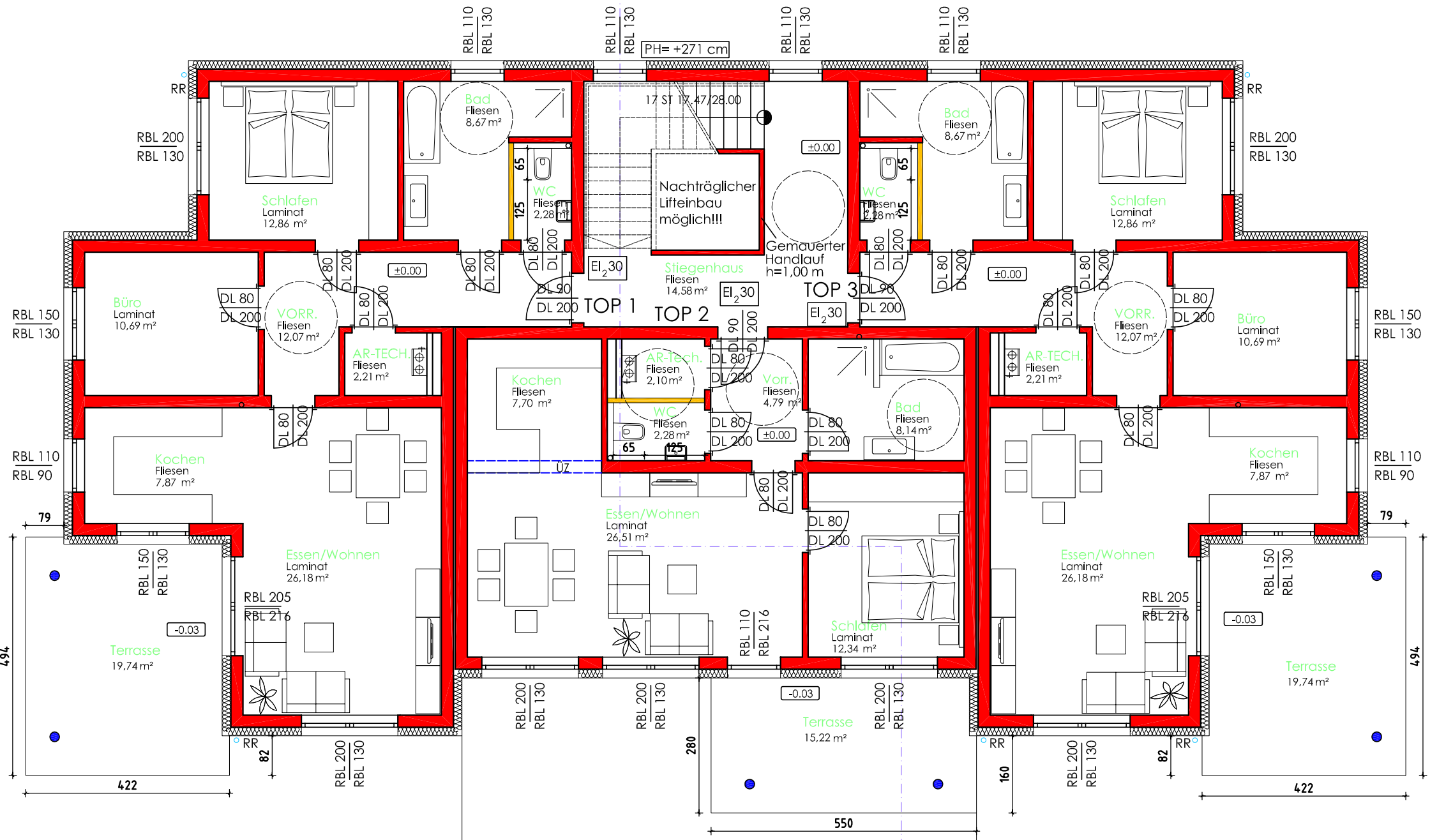
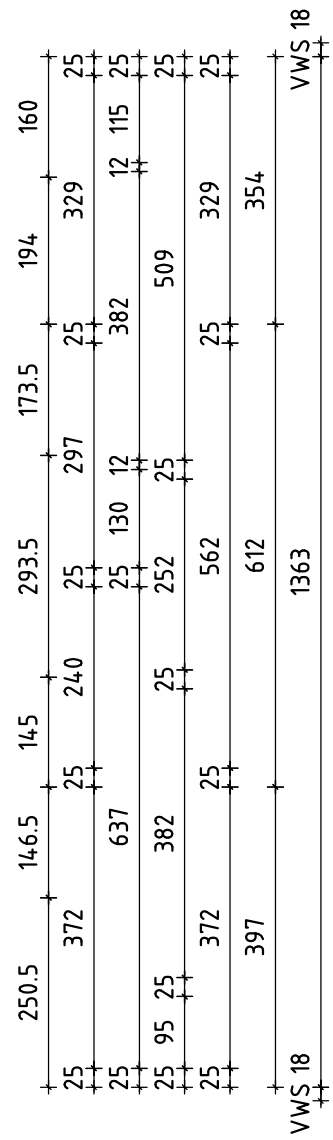
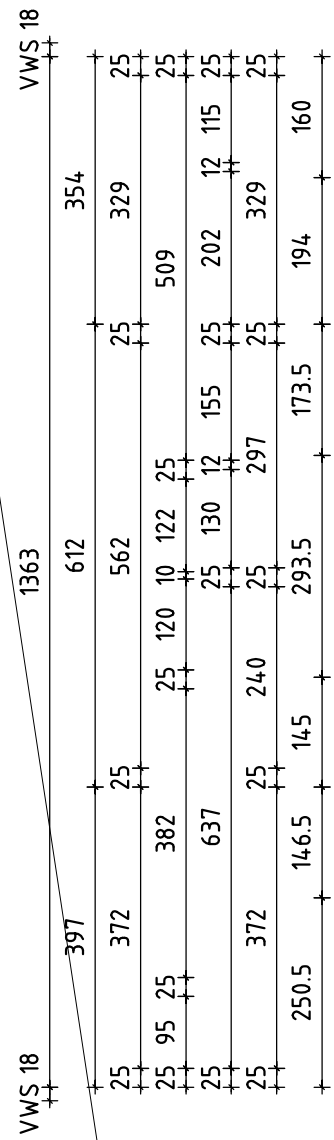
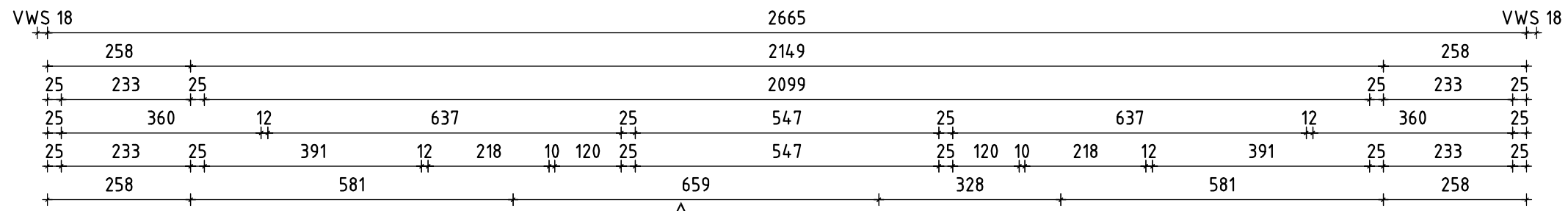

RBL=Rohbaulichte  
DL = Durchgangslichte

Wohnfläche Top 1	83,22 m²
Wohnfläche Top 2	64,22 m²
Wohnfläche Top 3	83,22 m²

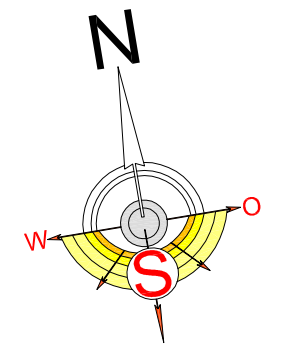

ERDGESCHOSS

